



BOLT ACTION AIR RIFLE **MOD24**

HANDLING CAUTIONS AND INSTRUCTION MANUAL

MODIFY and its logo are registered trademarks.

We promise our customers the best services and premium quality products with value.
Please visit our website at www.modify.com.tw and leave your comments.



THANK YOU FOR PURCHASING MODIFY PRODUCT. PLEASE READ THIS MANUAL CAREFULLY.

 <p>Receiver Assy</p> <p>Stock</p> <p>Long Screw</p> <p>Short Screw</p> <ul style="list-style-type: none">Smooth and Quick Cocking DeviceAdjustable Accurate Hop Up SystemWider Textured Adjustable TriggerRemovable Picatinny Top RailSteel Cylinder and Enhanced Metal Internal PartsRemovable Illuminate Magazine with 30 RoundsNon-pellet Alert Function	<p>If Receiver Assy and the Stock are packed separately in case. Please follow the Assembly Step:</p> <ol style="list-style-type: none">(1) Assemble "Receiver Assy" with the stock.(2) Fix the stock with the screws as shown by using a 3mm hexagonal key. Please adjust the screws properly. The assembly is finished.
--	--

CONTENTS

1.	WARNING & CAUTIONS.....	1
2.	OUTLOOK / STRUCTURE.....	2
3.	SAFETY.....	3
4.	SETTING MAGAZINE.....	3
5.	SETTING LED BOX.....	3
6.	BB LOADER.....	3
7.	ZEROING-IN.....	4
8.	ADJUST THE STOCK.....	5
9.	ADJUST THE TRIGGER.....	5
10.	BIPOD INSTALLATION.....	6
11.	MAINTENANCE.....	6
12.	EXPLODED DIAGRAM.....	7

⚠ WARNING! ⚠

- +18** | NOT A TOY. USER RESTRICTED TO 18 YEARS OF AGE OR OLDER.
-  | ALWAYS KEEP THE AIRSOFT GUN POINTED IN A SAFE DIRECTION. THIS AIRSOFT GUN MAY CAUSE SERIOUS INJURY IF MISUSED OR MISHANDLED.
-  | ALWAYS READ THROUGH ALL INSTRUCTIONS BEFORE USING.
-  | THE PURCHASER AND USER SHOULD CONFORM TO ALL LAWS GOVERNING OWNERSHIP, TRANSPORT AND USE OF AIRSOFT GUNS.

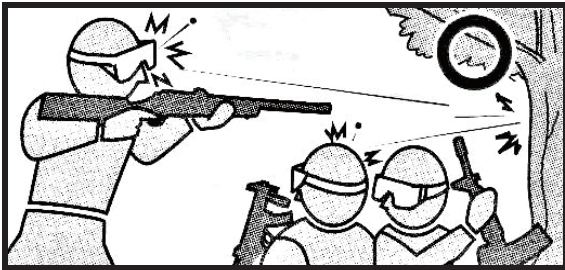

Always wear eye protective gear.

When shooting airsoft gun for a target or game, you and all participants, you and all participants must wear goggles or other eye protective gear, also paying attention to ricochets. (Pay sufficient attention also to third personnel other than participants.)

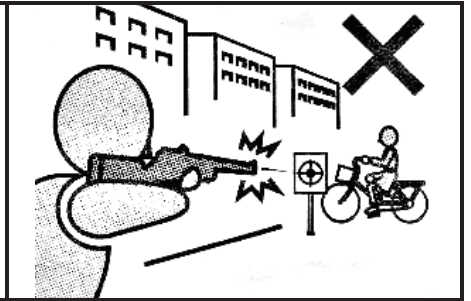
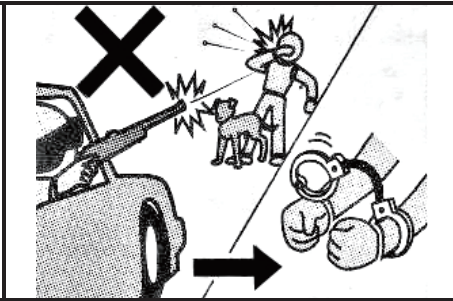
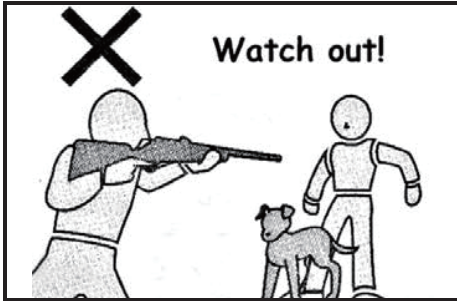

Never aim or shoot a person or animal as the target.

Never shoot as joking, always look before shoot, careless use may cause injure and be punished.

Never shoot airsoft gun at places where people and cars pass cross.

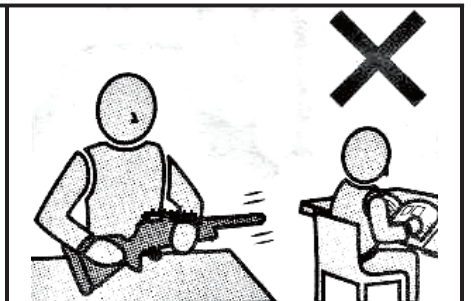
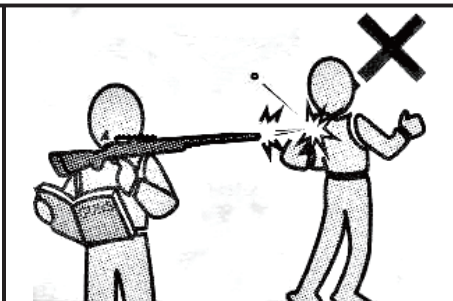

Never look into gun muzzle.

Avoid pulling the trigger carelessly.

Always keep airsoft gun pointed in safe direction.

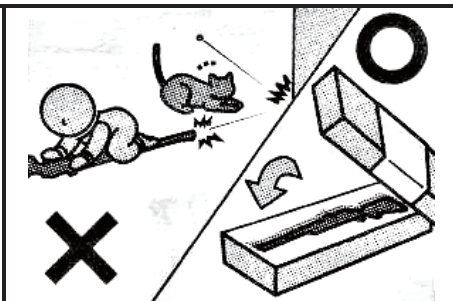
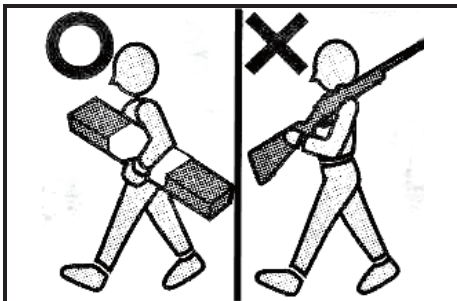

Do not carryout in public place, put into a case or bag for carrying.

Store airsoft gun at places out of reach by children.

BB pellets may be shot out even if the magazine is removed.

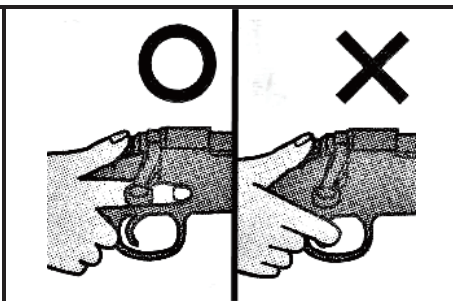
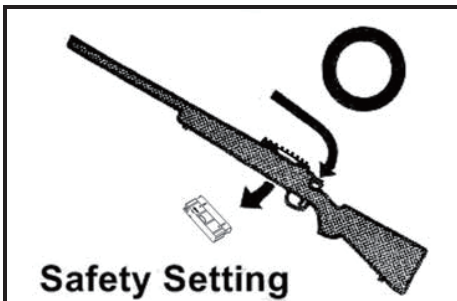

Always set the selector lever to Safety position until ready to shoot. Always keep airsoft gun unloaded until ready to use.

Always keep your fingers away from trigger until ready to shoot.

Never disassemble or modify airsoft gun, to avoid causing troubles and dangerous.

⚠ WARNING

- The operation procedure varies according to the model. Make sure to operate an airsoft gun after recognizing its features.
- We are not responsible for any accidents, events, injuries or repair costs arising from wrong operation and handling or by modification and disassembly of the gun.
- Repair cost is payable if user damages product with DIY work.

SET CONTENTS

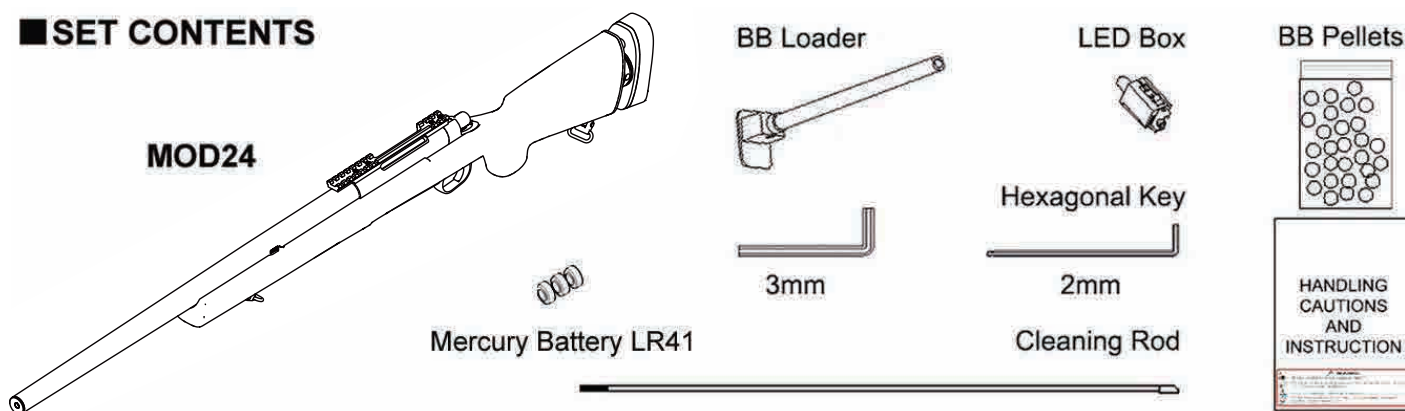

Notice before Operation:

After receipt of the MOD24, immediately unpack and inspect it for any shipping damage or missing parts. If any sign of damage or missing parts are found, immediately notify the dealer. Promptly request a copy if you lose the Handling Cautions and Instruction Manual.

2. Outlook / Structure

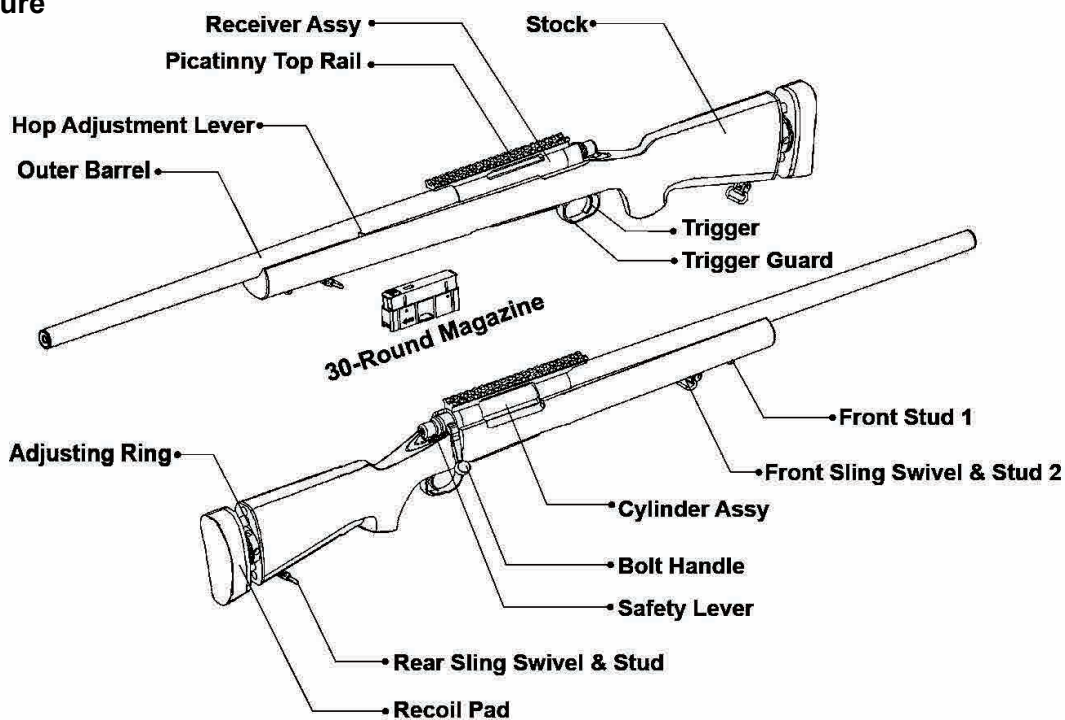

	MOD24	MOD24 USR150/X/SF/SPS	MOD24X G-spec
Weight	2.8 kg	2.8 kg	2.8 kg
Length	110 cm	110 cm	110 cm
Barrel Length	485 mm	485 mm	325 mm
Hop-up	Adjustable	Adjustable	Adjustable
Magazine Capacity	30	30	30
Major Color	BLACK/O.D./TAN	BLACK/O.D./TAN	BLACK/O.D./TAN
Shooting Mode	Bolt Action	Bolt Action	Bolt Action
Barrel Caliber	6.08 mm	6.03 mm	6.03 mm
Pellet Type	6 mm BB	6 mm BB	6 mm BB
Initial Pellet Speed	426 fps.	492 fps.	492 fps.

Remark : Muzzle energy output with 0.2g BB for Japan/Italy are 0.9 Joule.

3. Safety Setting

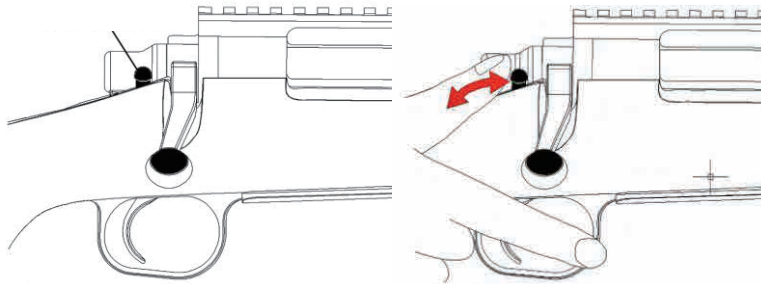

Always set the safety lever to SAFE until immediately before firing.

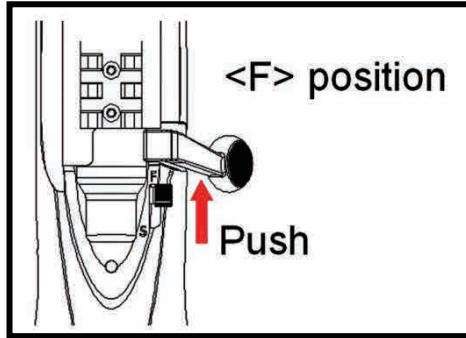
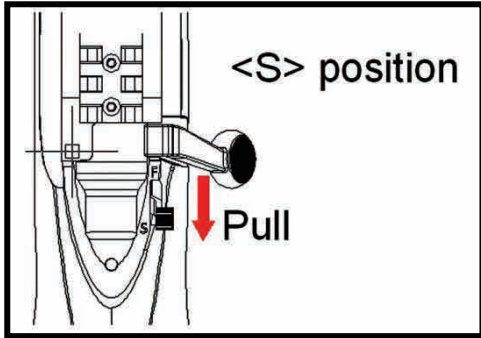

Caution:

- Never operate the Safety lever while pulling the trigger. Otherwise, malfunctions are possible, resulting in accidents.
- Pulling the trigger with the Selector being set to safe may damage the gun.

Safety lever to ON (S)
Pull the safety lever backward to S to make the safety function valid.
★ When you are not firing or during storage. Always set the selector to the safe position. ★

Safety lever to OFF (F)
Push the safety lever forward to F to release the safety.
★ The gun will fire one shot each time the trigger is pulled. ★

4. Setting Magazine

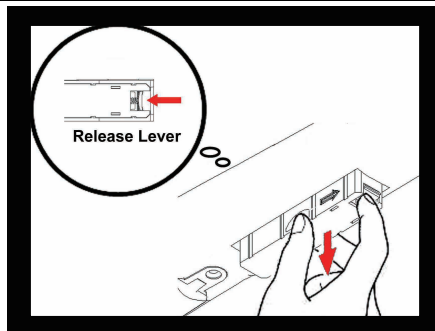

Press the magazine release button as shown to detach the magazine.

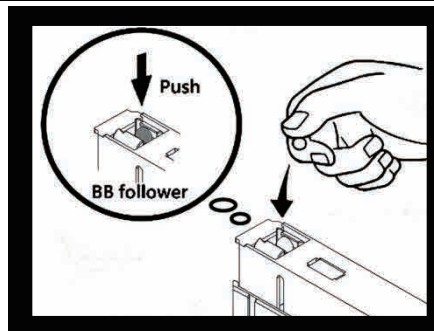

Push down the BB follower and feed BB pellets one by one. About 30 BB pellets can be loaded. Avoid forcing BB pellets into the magazine. Use our original BB loader for quick action.

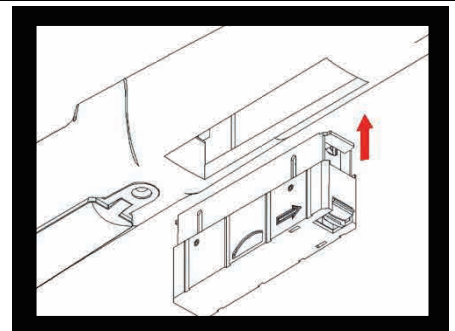

Always set the magazine upwardly. The pellet hatch in the magazine needs to be parallel to muzzle's direction. Hold the magazine horizontally and push upward until a click sound is heard.

Caution:

- Never use any used BB pellets. Always use the BB pellet supplied by MODIFY for this air gun. We shall not be held responsible for any damage or accidents arising from the use of pellets supplied by other manufacturers.

5. How to install the LED box

① Install the Battery

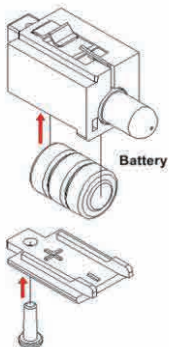

- ① Loosen the screw from the LED box to remove the battery cover plate.
- ② Install the attached three mercury batteries as shown.
- ③ Fasten the cover plate with the screw.

Caution:

Make sure the + and - battery contacts are properly oriented
The LED may not work when old and new batteries are used together

② Install the LED

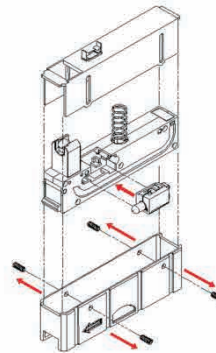

- ① Remove the four screws from the magazine
- ② Disassemble the magazine cover into upper and lower part. Take out the inner case.
- ③ Install the LED box into the magazine inner case as shown.
- ④ Assemble the magazine and tighten the four screws to finish.

5. How to use a BB loader

★ One Point advise ★

The BB loader can be used for MODIFY Air Gun series.

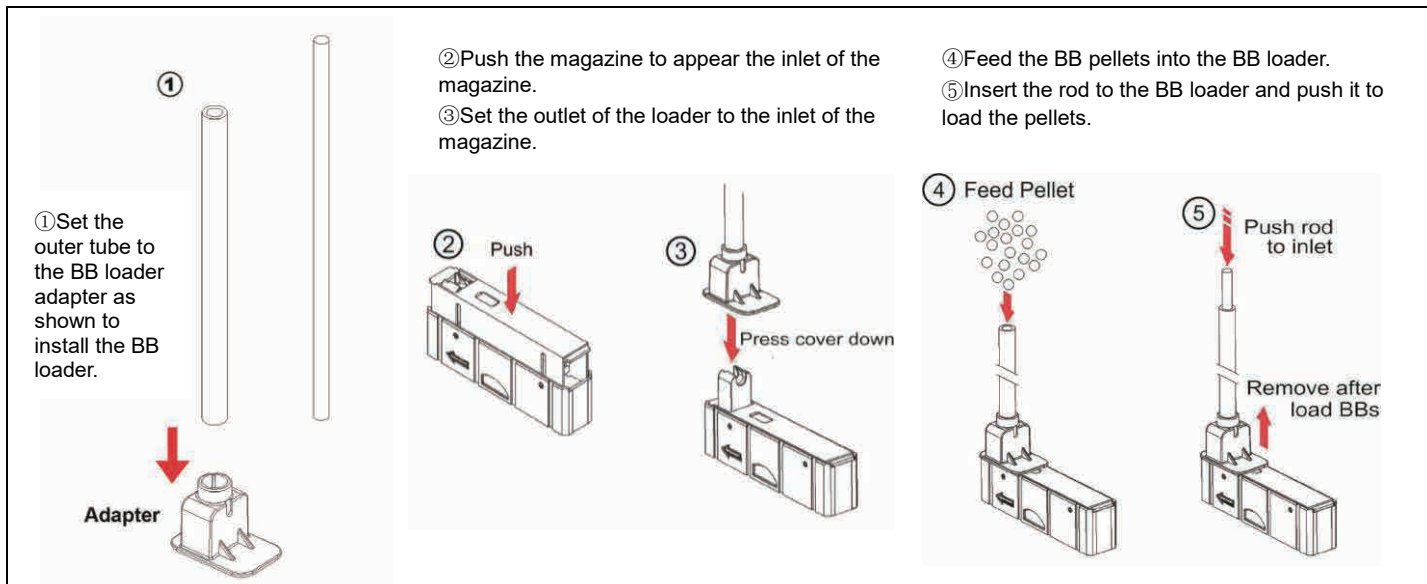

7. Zeroing-in

A. FIRING (Confirm safety sufficiently before beginning firing)

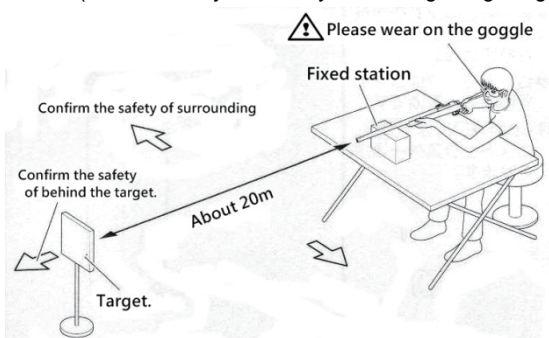

★ Before adjusting your hop-up and sight, shoot at a target testing the gun on something which can help steady the gun. ★

Caution:

- Make sure the target and shooting range is safety enough and it will not affect the others.
- Activating the trigger carelessly is extremely dangerous. Never put your finger onto the trigger unless you are ready to shoot a target.
- You can fire a pellet by only pulling the trigger slightly because this rifle is developed for game.

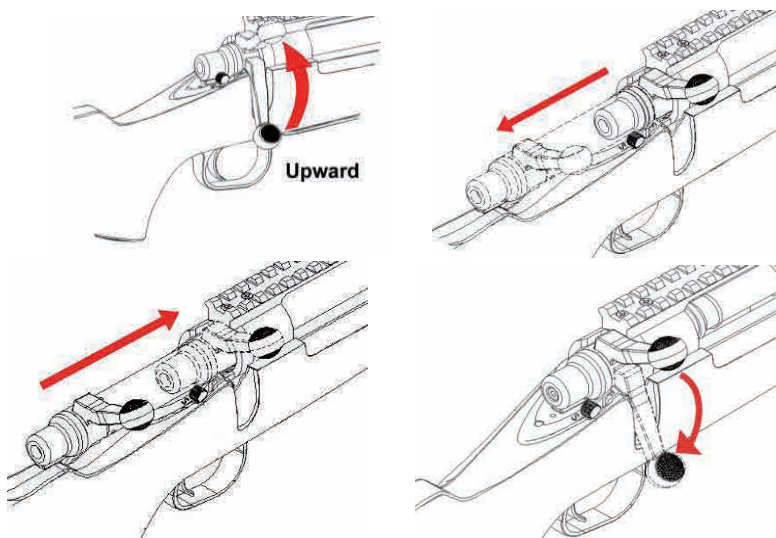

① Push the bolt handle upward and pull it backward as shown until a click sound is heard.

② Return the bolt handle and put it down to the original position. (The gun will not fire if the cocking lever is not put down completely)

Caution:

A Non-pellet Alert Function is available for this rifle. Remove the empty magazine before return the bolt handle is a must. Return the bolt handle furiously may damage the gun.

③ Set the safety lever to F to release safety.

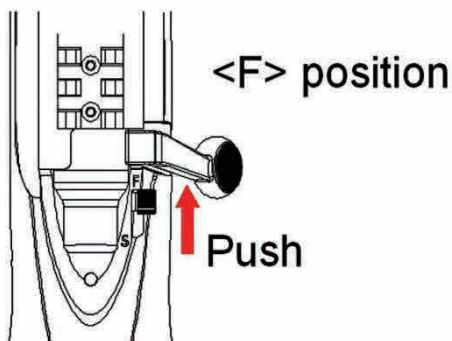

④ Pull the trigger. Firing.

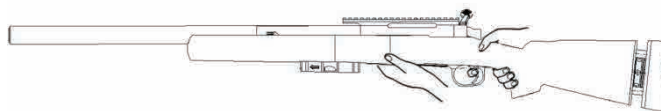

Check the target after shooting.

- Confirm that: The firing line to the target is horizontal.
- You can hit the mark.

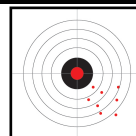

Caution:

- Outdoor shooting may be influenced by weather conditions such as wind.
- Be careful that pellets may fall if a bolt handle is returned with sufficient vigor when it is in a place with the hop lever near the normal position.

B. Adjustable Hop Up System

By producing a back-spin on the BB pellets, this system allows for straighter and longer distance shooting than normal air guns. The Modify adjustable hop up system permits one-touch adjustment using the dial and lever, making it an accurate hop up system.

Caution:

- Moving the lever too much towards HOP may cause clogging of pellets.
- If pellet clogging occurs, immediately stop firing the gun, return the hop adjustment lever to the Normal position and remove clogging pellets using the cleaning rod.
- Never use any used and dirty pellets.

★ Adjustment procedure (Adjust by carrying out trial firing, referring to 6 on page 6 of the manual) ★

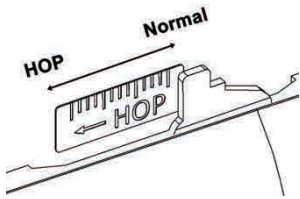

- Turning excessively adversely affects the trajectory. So, stop turning the hop adjustment lever when pellets fly horizontally.
- The hop up dial can only be turned a certain amount. Turning it too much will damage it.

★ The best position is where the pellets fly horizontally and the longest flying distance is obtained. ★

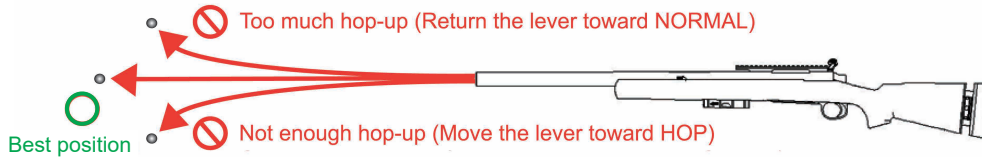

BB pellets can be shot horizontally in long distance.

When Hop Up is improper

Symptom	Cause	Action
Severe flying up.	Too much hop setting.	Gradually return adjustment lever towards Normal.
Short flying distance of pellets. (less hopping up effect)	Too much hop setting.	Gradually return adjustment lever towards Normal.
	Hop Up bucking is contaminated by oil or dirt.	Fire pellets equivalent to 4 or 5 magazines or clean the chamber using the cleaning rod.
	Badly worn hop up bucking.	Purchase the replacement parts at your dealer or from MODIFY and replace it.
Cannot adjust	Damaged adjustment lever or other worn parts.	Purchase the replacement parts at your dealer or from MODIFY and replace it.
Frequent pellet clogging.	Too much hop setting.	Gradually return adjustment lever towards Normal.
	Poor or too large sized BB pellets.	Use the BB pellet supplied by MODIFY.
	Dirty bore.	Clean using the cleaning rod or consult your dealer or MODIFY for repair.

8. Adjust the Stock

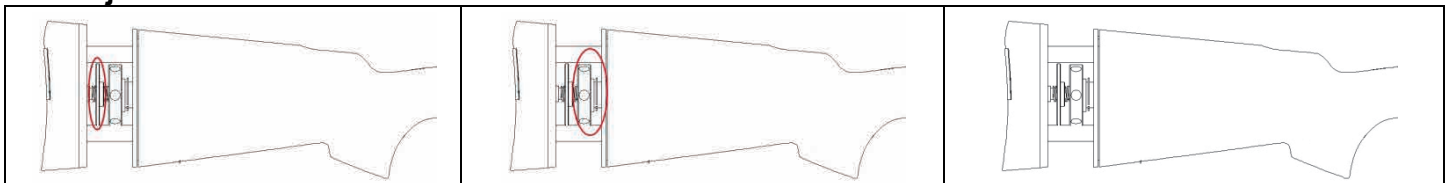

Loose the lock ring.

Adjust the length by turning the adjustable ring.
Adjustable range: about 65 mm

Fixed the length by locking the lock ring to the adjustable ring tightly.

9. Adjust the Trigger

Trigger Pull Adjustment

Adjust the trigger pull force by turning the trigger weight screw using the attached small hexagonal key.

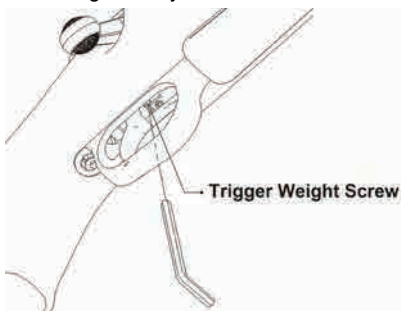

- Turn clockwise to increase the force needed to pull the trigger.
- Turn counterclockwise to decrease the force needed.
- ★ If you turn the screw excessively, the screw may come off. ★

Trigger Travel Adjustment

Adjust the trigger travel by turning the trigger stop screw using the attached small hexagonal key.

Directly adjust trigger without any disassemble.

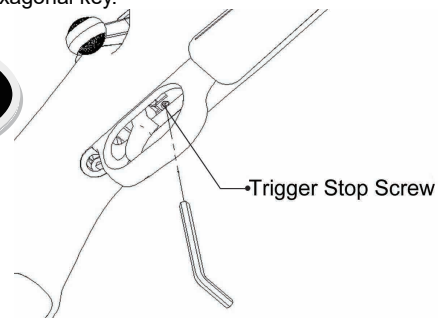

- Turn clockwise to reduce the trigger travel.
- ★ Do not turn the screw excessively to make the trigger activate. ★
- Turn counterclockwise to increase the trigger travel
- ★ If you turn the screw excessively, the screw may come off. ★

10. Bipod Installation

Installing a bipod on your rifle can greatly enhance your accuracy while target shooting.

Studs

- Loosen the screw on the bottom side of the bipod, releasing tension from the bipod's clamp.
- Place the clamp on the front stud affixed in the stock--the retention pins located in the clamp's interior should insert into both sides of the stud's hole.
- Tighten the screw on the bottom of the bipod, causing the clamp to secure on the stud.

11. Maintenance

- Drop a few drops of silicone oil from the pellet entrance, then fire pellets equivalent to 1 or 2 magazines.
- Use the cleaning rod (with cotton) as shown below, to remove the excess oil to complete the maintenance.

Caution:

- Always begin the maintenance by returning the hop-up adjustment lever to the Normal (HOP-OFF) position.
- The inside chamber is a precision component, it can be damaged easily. Be careful during maintenance. Never use any used pellets.

How to use a cleaning rod
Cut a cotton cloth to the size as shown and insert one end into the hole in the rod. (Adjust the length of the cloth for smooth entry into the barrel.)

Caution:
Inserting the rod will be difficult if you hold rod at the end.

Hold at the leading end of the rod and insert the rod into the barrel while turning the rod.

Removing Clogged Pellets (Set the safety.)

When pellets are clogged, immediately stop operation. Remove clogged pellets and then restart operation of the air gun.

- Return the hop up lever to the Normal position and insert the cleaning rod from the lead edge of the barrel.
- Always insert the cleaning rod by the angled part facing down, and remove clogged pellets.

Caution:
Since clogged pellets may jump out at a high speed, always wear safety goggles and confirm safety.

12. Exploded Diagram

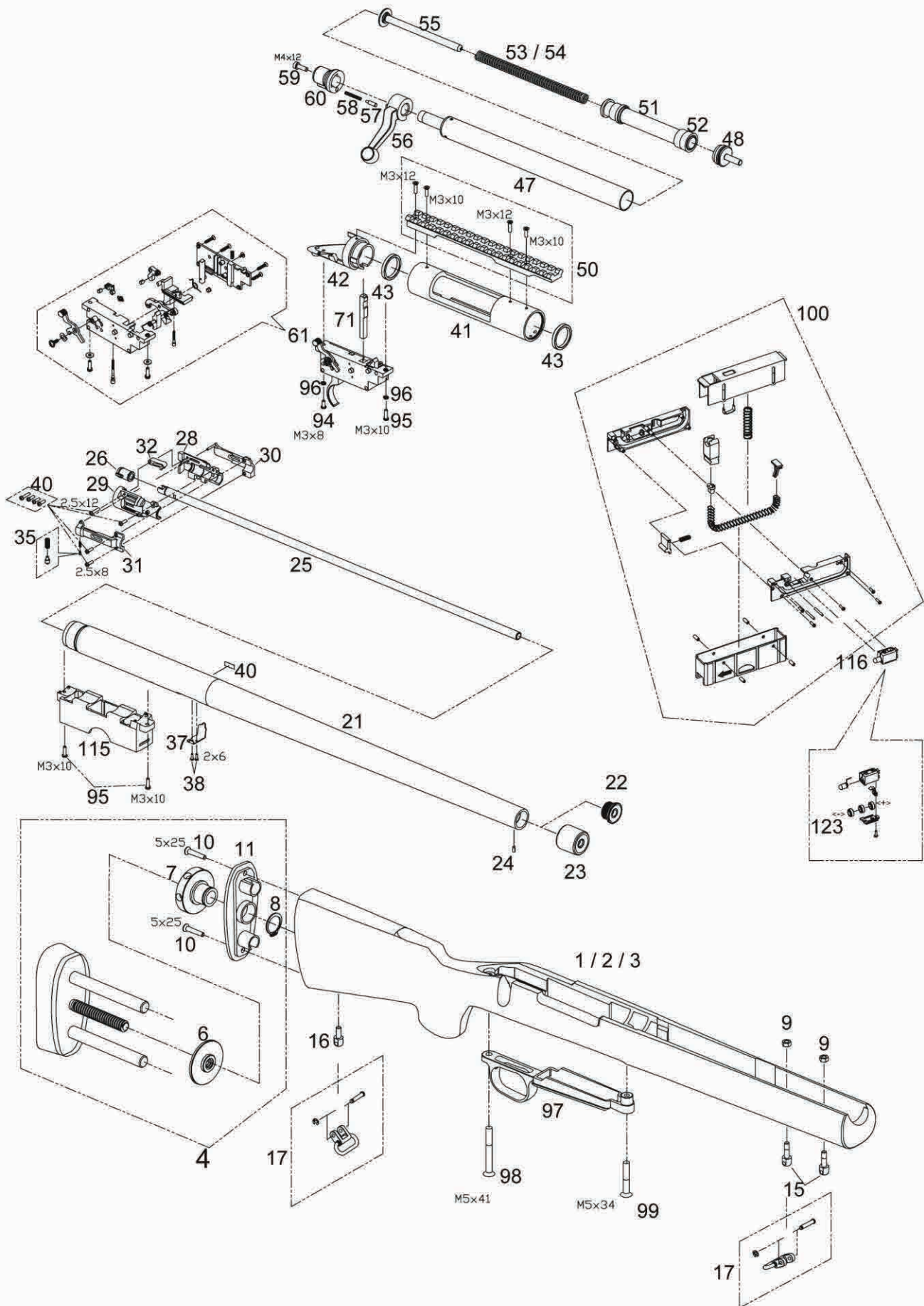



User manual supplemental instruction

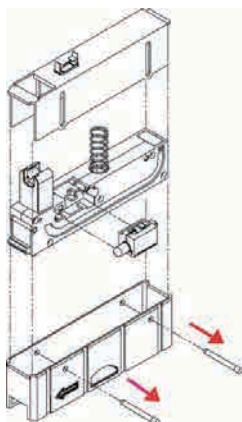

We do the further improvement for better disassembling. Here are some changes on user manual:

Install the LED

1. Remove the 2 pins from the magazine.
2. Disassemble the magazine cover into upper and lower part. Take out the inner case.
3. Install the LED box into the magazine inner case as shown.
4. Assemble the magazine and tighten the 2 pins to finish.

Caution:

A Non-pellet Alert Function

A Non-pellet Alert Function is available for this rifle. Remove the empty magazine before return the bolt handle is a must. Return the bolt handle furiously may damage the gun.



BOLT ACTION AIR RIFLE **MOD24**

HANDLING CAUTIONS AND INSTRUCTION MANUAL

MODIFY與其商標已做相關商標註冊
提供最好的服務和優質的產品
您可以造訪摩帝的網頁並留下您寶貴的建議

感謝您的購買，使用前請先詳閱說明書。



Stock

Receiver Assy

Long Screw

Short Screw

滑順和快速安裝
可調式HOP系統
可調整板機
可拆卸的皮卡汀尼鏡軌
鋼製汽缸和強化的金屬內部零件
可拆卸的LED發光彈匣(可容納30發BB彈)

上、下槍身分散包裝於盒內，請參照以下組裝說明：

- (1) 將上槍身與下槍身結合。
- (2) 請依照圖是將槍托長、短固定螺絲以 3mm 六角扳手適度旋緊，完成組裝步驟。

目錄

1.	警告 & 注意事項	1
2.	外觀 / 結構	2
3.	保險	3
4.	彈匣安裝	3
5.	LED 發光器安裝	3
6.	填彈器	3
7.	歸零矯正	4
8.	後托調整	5
9.	板機調整	5
10.	腳架安裝	6
11.	保養	6
12.	爆炸圖	7

⚠ WARNING! ⚠

+18 | 未滿18歲禁止購買，12歲以上需家長陪同。



| 請隨時保持槍口安全方向，若造成傷害請自行負責。



| 使用前請詳細閱讀說明書。



| 運輸和使用玩具槍應遵守所有相關法律責任。

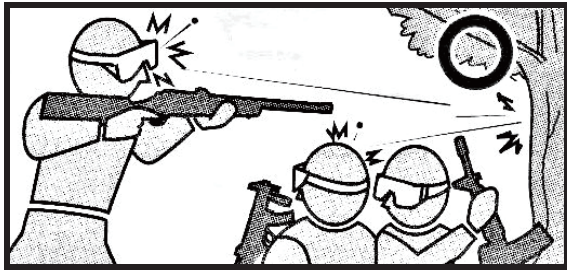

請戴上護目鏡

當射擊此空氣槍時，所有參與者必須配戴護目鏡或其他眼部護具，請注意流彈，並應提醒其他在場人員要特別注意安全。

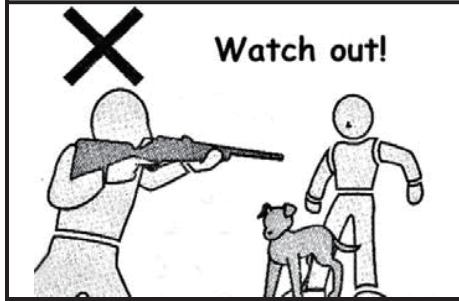

請勿將槍口指向人或動物。

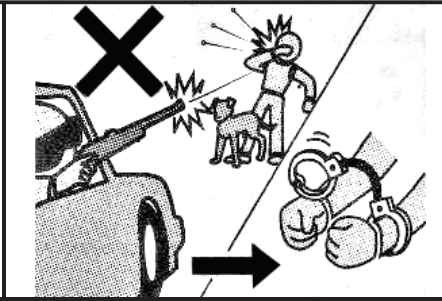

射擊不是玩笑，請於射擊前看清楚目標物。粗心的使用可能會造成傷害，進而遭受處罰。

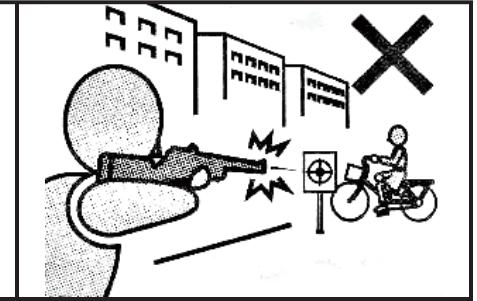

請不要在人、車經過的地方射擊。

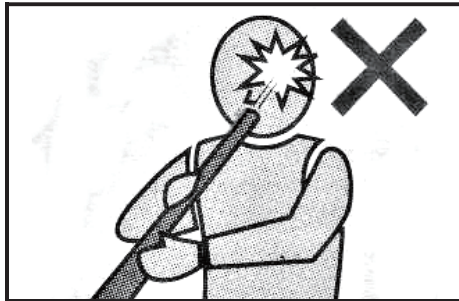

請不要直視槍口。

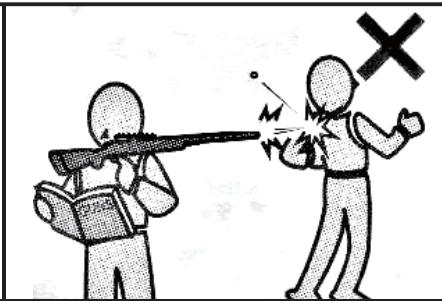

請避免不小心的板機扣壓。

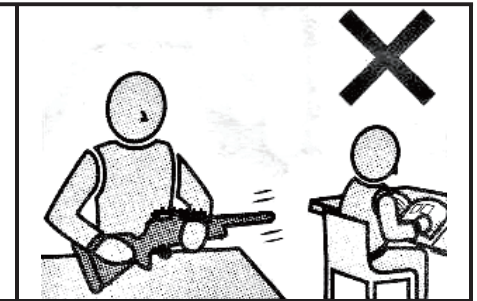

請保持槍口朝向安全位置。

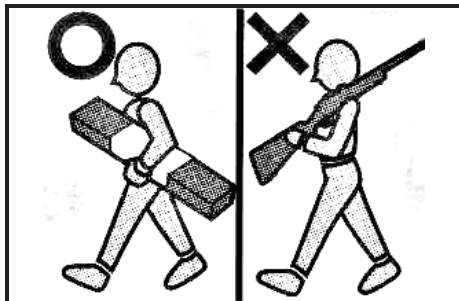

請不要在公共場合隨意攜帶槍支，應將槍支放入槍盒或是槍袋中以便攜帶。

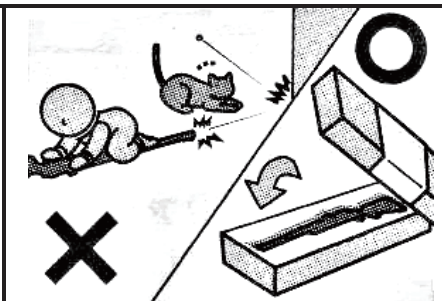

請將槍支安全的放置在孩童無法拿取的地方。

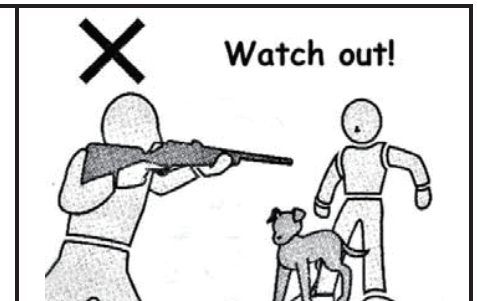

即使彈匣取出，BB彈也有可能從槍中射出去，請小心使用。

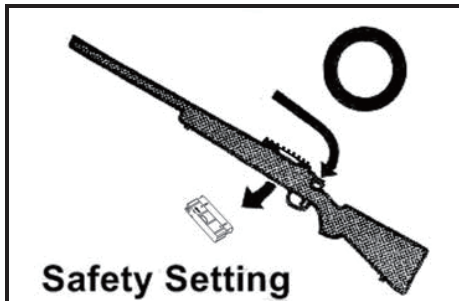

尚未射擊前，請將安全調節桿設定在 Safety 位置。

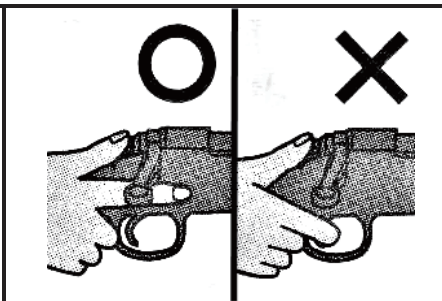

尚未射擊前，請讓手指離開板機。



請不要自行拆卸或修改此槍。

警告

- 操作步驟根據型號而有所不同。請了解認識該空氣槍各項功能後，再操作此空氣槍。
- 摩帝企業有限公司對於因錯誤操作和處理發生的事故、意外、受傷，或因修改和拆卸槍支所產生的維修費用不負任何責任。
- 使用前注意事項：
當您收到MOD24時，請檢查有無損毀或缺少零件。若發現有上述情況時，請立即與您購買的店家聯絡。
如果遺失操作手冊，請即時索取。

使用前請先閱讀說明書

■ 內容物

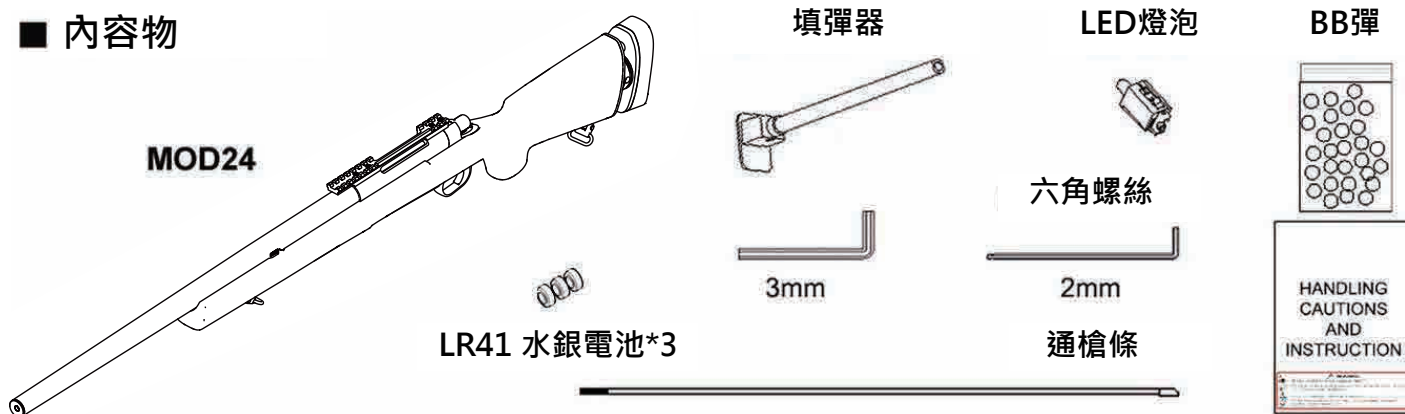

操作前注意事項：

收到MOD24後，請立即打開包裝並檢查任何運輸損壞或缺少零件。
 如果有任何損壞跡象或找不到零件，請立即通知經銷商。如果丟失操作注意事項和使用說明書，請立即提出。

2. 外觀 / 結構

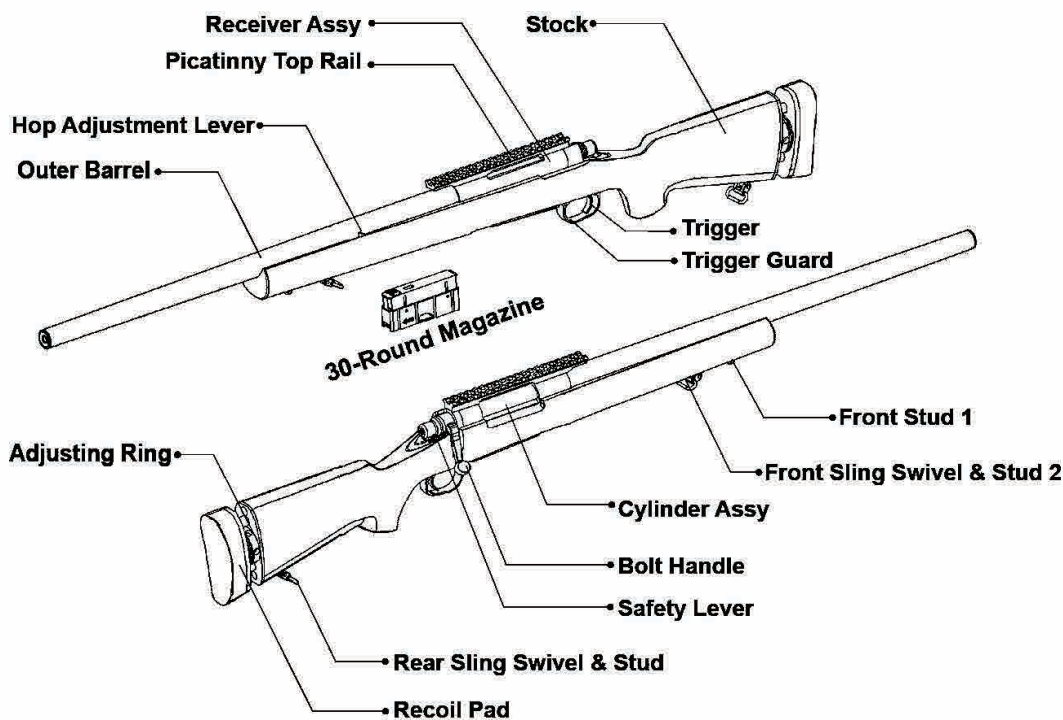

	MOD24	MOD24 USR150/X/SF/SPS	MOD24X G-spec
重量	2.8 kg	2.8 kg	2.8 kg
長度	110 cm	110 cm	110 cm
內管長度	485 mm	485 mm	325 mm
Hop-up	可調整	可調整	可調整
彈量	30	30	30
顏色	黑色/綠色/沙色	黑色/綠色/沙色	黑色/綠色/沙色
動力來源	手拉空氣	手拉空氣	手拉空氣
內管口徑	6.08 mm	6.03 mm	6.03 mm
彈種	6 mm BB	6 mm BB	6 mm BB
出廠初速	426 fps.	492 fps.	492 fps.

動能會因寄送國家而有所改變：日本/義大利為0.9焦耳 (0.2g BB)

3. 保險設定

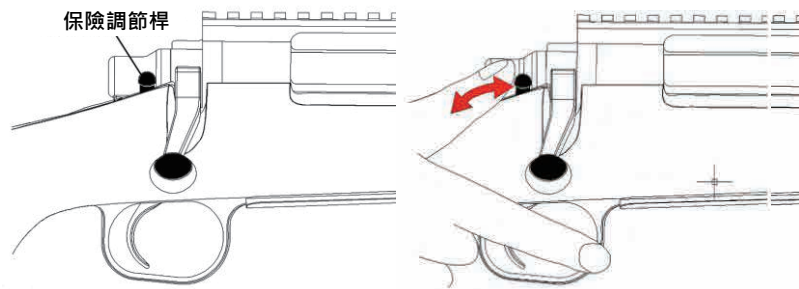

請將保險設在 SAFE 的位置，直到射擊前。

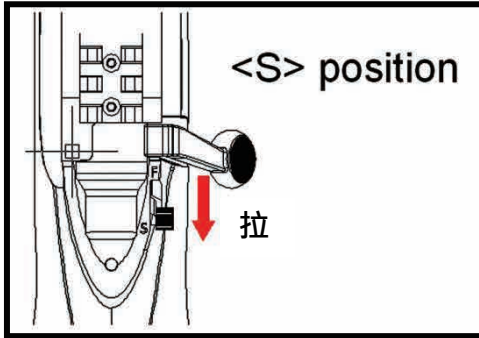

保險裝置 ON
向後扣壓保險桿直到 S 位置使保險功能有效。

★ 未射擊時，請務必將保險扣上，保護措施一定不能忘記。

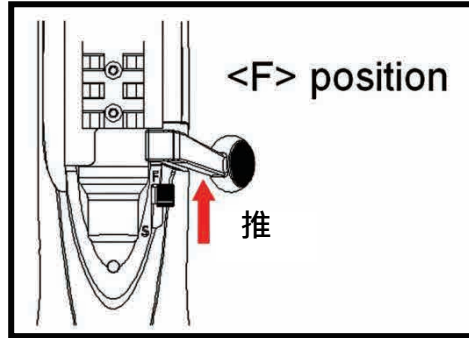

保險裝置 OFF
前推保險桿直到 F 位置以釋放保險。

★ 此空氣槍每扣壓一次扳機只會射擊一發 BB 彈。

Caution:

- 請務必不要在扣壓扳機時操作保險，否則可能發生故障，導致意外。
- 保險扣上時扣壓扳機，會有損槍枝。

4. 彈匣安裝

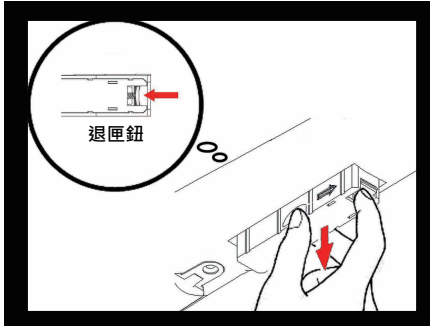

如圖所示按壓彈匣退出鈕取出彈匣。

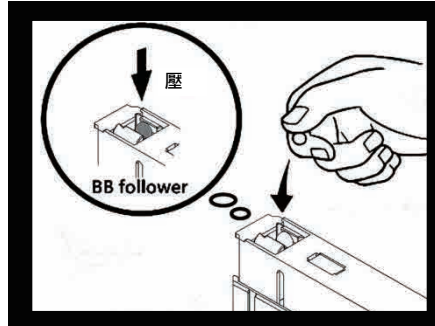

按壓 BB 彈的上彈頭，並一顆一顆的裝填 BB 彈。一個彈匣可以容納 30 顆 BB 彈。請不要強迫過量裝填。使用本公司所附之『填彈器』可以更快速的裝填 BB 彈。

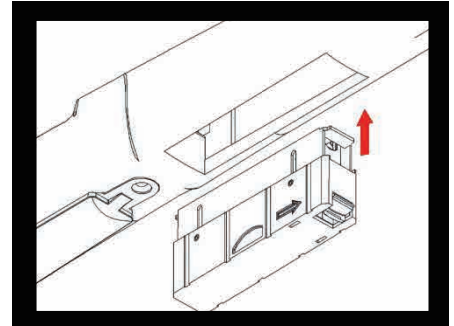

安裝彈匣的時候請務必朝向上方，彈匣的出彈口務必與槍口方向平行。水平握住彈匣由下往上推，直到聽到喀擦聲扣住。

Caution:

- 請選擇 MODIFY 供應的 BB 彈。如果使用其他廠牌的 BB 彈，而導致槍枝故障或是意外，本公司一概不承擔責任。

5. 安裝 LED 發光器

① 安裝電池

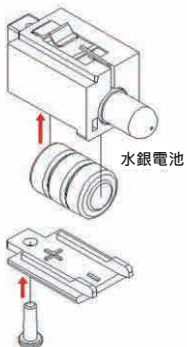

- ① 鬆開電池盒蓋上的螺絲，移開電池盒蓋。
- ② 如圖所示，將水銀電池安裝置 LED 發光器內。
- ③ 扣上電池盒蓋後，將螺絲鎖上。

Caution:

安裝時請注意電池的正負極方向，新舊電池不要混合使用。

② 安裝 LED 發光器

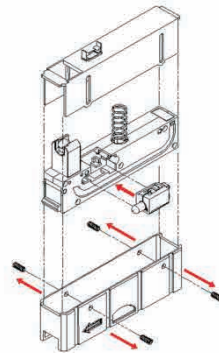

- ① 先拆除彈匣上的 2 支 PIN。
- ② 分離彈匣上/下外蓋，取出彈匣內盒。
- ③ 如圖所示，將發光器置入彈匣內盒，
- ④ 將彈匣組裝，鎖上四顆螺絲。

5. 填彈器使用方法

★ One Point advise ★

此 BB 彈填彈器適用於 MODIFY 空氣槍系列。

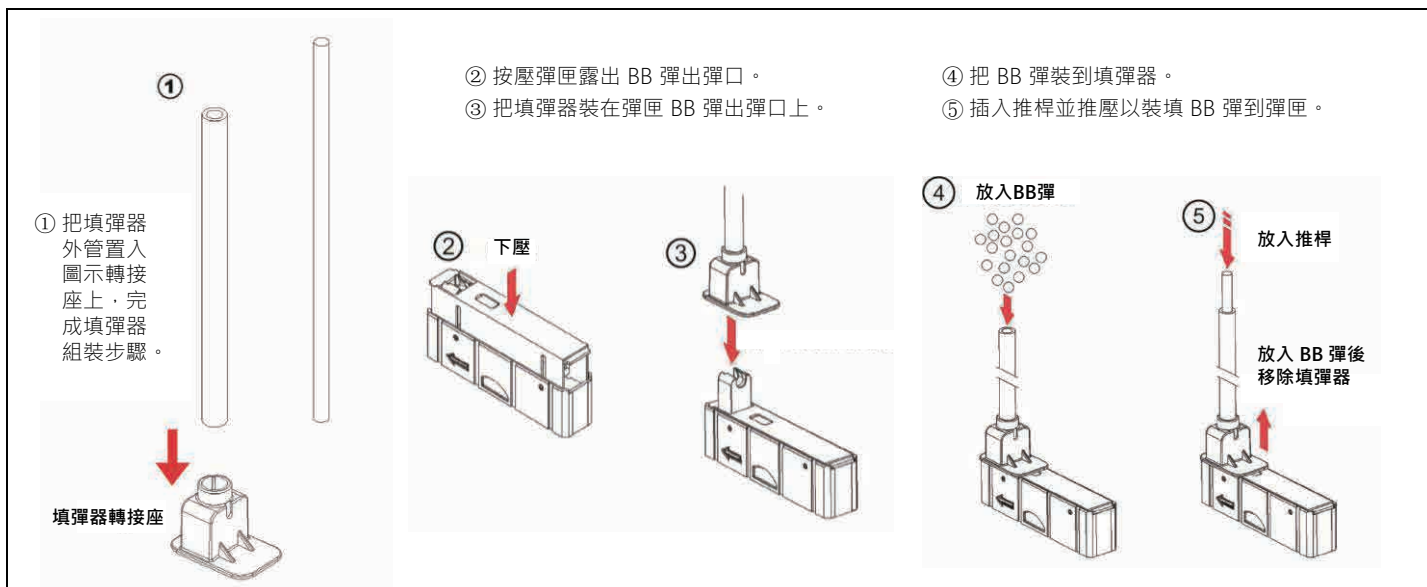

7. 歸零校正

A. 射擊 (在開始射擊前請先確認保險是有效的)

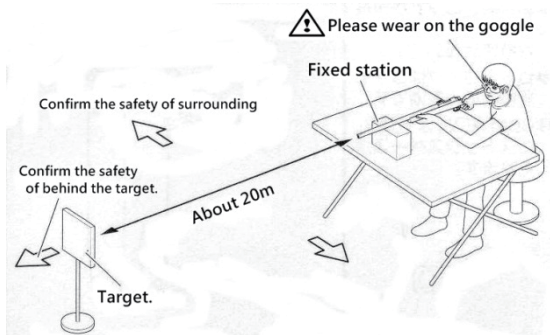

★ 在調整 HOP-UP(彈道)與瞄準具前，將槍固定在定點，並瞄準靶射擊，可以穩固槍身。★

Caution:

- 確認射擊場地的環境與標靶的後面是否安全。
- 不當的使用扳機是非常危險的。除非已經瞄準好準備射擊，否則不要把手指放在扳機的位置上。
- 這把來福槍是做為遊戲使用，只需輕扣扳機，即可擊發子彈。

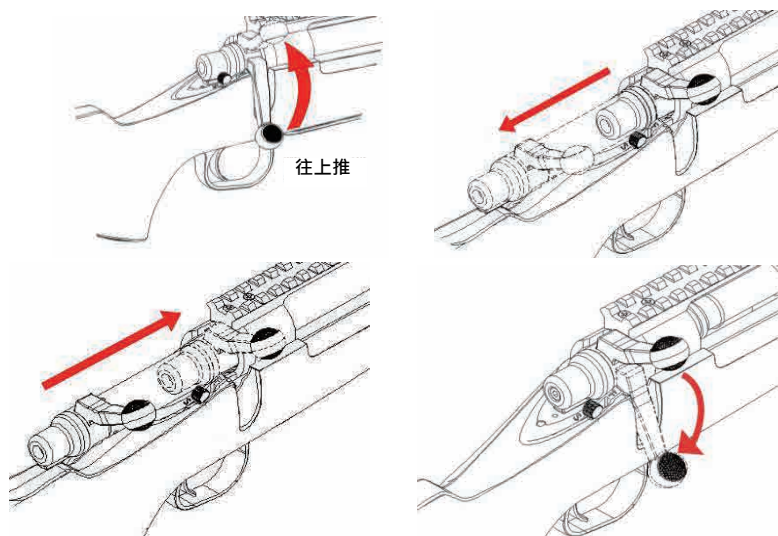

① 拉柄往上推，並如圖所示往後拉，直到聽到喀擦聲。

② 將拉柄後拉到底再推回，然後向下壓放歸位。
(射擊前如未確實將拉柄下壓歸位，則無法擊發。)

④ 扣下扳機。

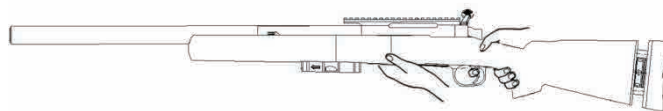
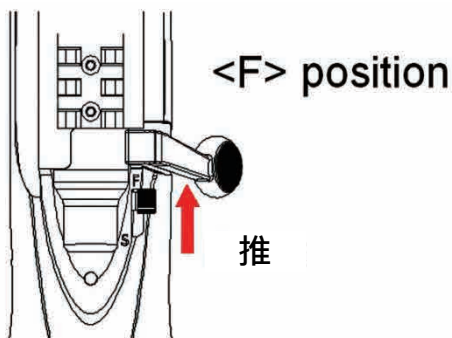

射擊後檢視落靶位置

- 彈道是否平直
- 靶位是否可以擊中

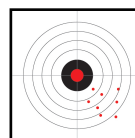

Caution:

- 室外射擊可能會受天氣影響。
- 請確認標靶的射擊範圍內有足夠的安全空間，並且在此範圍內不影響他人。

B. 可調式 HOP UP 系統

藉由 B.B.彈產生的上旋，此系統有考慮到比一般的空氣槍更平直且更長遠的射程。Modify 可調式 HOP UP 系統，可簡易的調撥調整桿，使 HOP UP 調整得更精確。

Caution:

- 調整 HOP-UP 外調桿，太接近『HOP』位置時，會容易卡彈。
- 如發現卡彈情形時，請立即停止射擊，將 HOP-UP 外調桿調整到原來的位置上，並清除子彈。
- 請勿使用品質不良或是髒汙的 BB 彈。

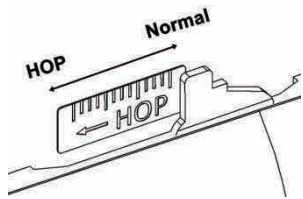

★ 調整過程(試射，請參閱說明書第 4 頁) ★

- 調整桿調整過多時，會嚴重影響彈道，調整 HOP-UP 外調桿直到彈道正常平直的位置即可。
- 刻度表能顯示調整桿位置，確實的發揮彈道效果。

★ 最佳的位置是水平飛行，此位置 BB 彈可以飛得更遠。★

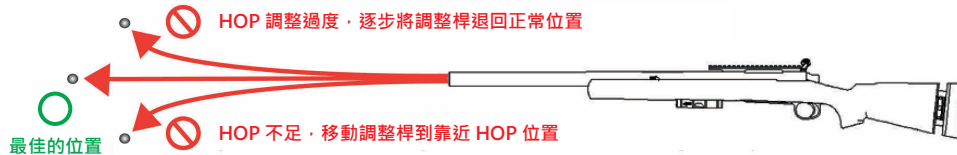

BB 彈在水平位置上，可以飛得更遠。

HOP UP 未在適當位置

症狀	原因	調整方式
激烈上揚	Hop 調整太多	逐步將調整桿調到正確位置
激烈下墜	Hop 調整不足	
激烈下墜	橡皮(進彈圈)含有過量油汙	將油汙清除
	橡皮(進彈圈)嚴重磨損	更換橡皮
Hop-Up 不正常	零件損壞	更換零件
經常卡彈	Hop-Up 太緊	將調整桿退回正常位置
	BB 彈不良	使用 6mm 品質好的 B.B.彈
	槍管太髒	用棉棒清潔槍管

8. 後托調整

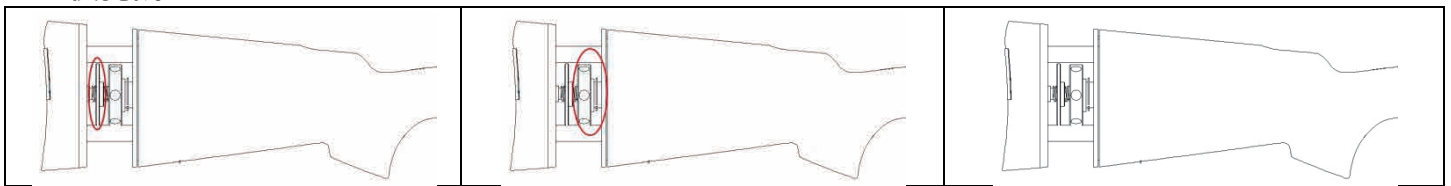

鬆開固定環(薄環)

旋轉調節環來調整後托長度調整範圍:約 65mm

將調節環旋向固定環以固定後托

9. 扳機調整

扳機力度調整

用 2mm 六角扳手，來轉動扳機調整座螺絲以調整扳機扣壓的強弱。



扳機力度調整螺絲

扳機行程調整

用 2mm 六角扳手，來轉動扳機調整座螺絲以調整扳機行程。

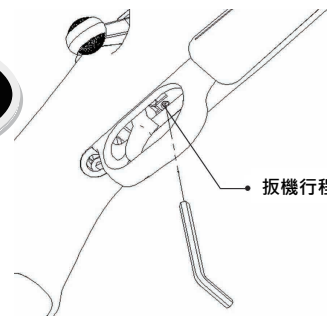

扳機行程調整螺絲

無需拆卸即可直接調整

- 順時針轉動上緊螺絲，會增加扳機扣壓力度。
- 逆時針轉動釋放螺絲，會減弱扳機扣壓力度。

★ 逆時針轉動過多，會使扳機扣壓過弱，且六角螺絲可能容易鬆落 ★

- 順時針轉動，可以減少扳機行程。
- 逆時針轉動，可以增加扳機行程。

★ 如果轉動過多，螺絲可能容易鬆落 ★

10. 腳架安裝

安裝腳架可以強化射擊時的準確度。

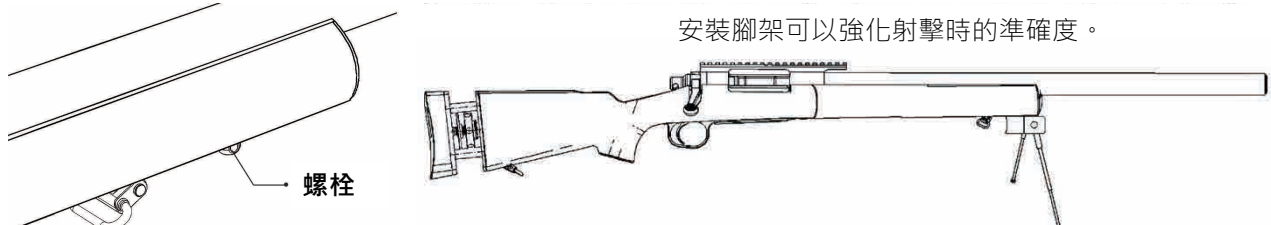

螺栓

- ① 鬆開腳架底部的螺絲，鬆開腳架。
- ② 將腳架的夾具緊貼前面的螺栓，張開在夾具內的插銷，再將插銷栓進螺栓的孔洞。
- ③ 鎖緊腳架底部的螺絲，確保腳架有穩固的安裝。

11. 保養

- ① 在子彈的入口滴幾滴矽油或是鐵弗龍油，並射擊約 1 到 2 個彈匣量的子彈。
- ② 使用清潔棒（有棉花），如下圖所示，以除去過量的油。

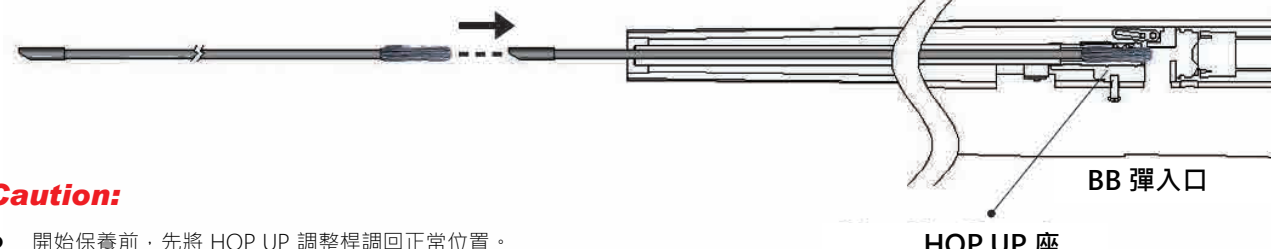

BB 彈入口

HOP UP 座

Caution:

- 開始保養前，先將 HOP UP 調整桿調回正常位置。
- 空氣鎗內部是精密的組件，會輕易被損壞。在保養過程中要小心。切勿使用已經用過的 BB 彈。

★ 如何使用通槍條：

裁切棉布的大小，如圖所示，將其一端穿過通槍條的孔位中。
（調整長度，使通槍條可順利進入槍管內）

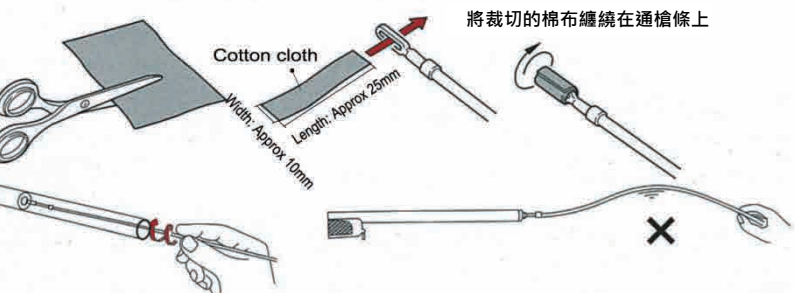

Cotton cloth
Width: Approx 10mm
Length: Approx 25mm

將裁切的棉布纏繞在通槍條上

Caution:

通槍條伸入槍管內清理時，請避免持握在通槍條末端位置。

握住通槍條後端位置，放入槍管再旋轉通槍條，擦拭槍管內部。

清除卡彈 (保險設在 SAFE 的位置)

卡彈時，應立即停止操作。取出卡彈，再重新操作空氣槍。

- ① 將 HOP UP 調回正常位置，再將清潔棒放入槍管的前緣。
- ② 務必將清潔棒的角度朝下，然後取出卡彈。

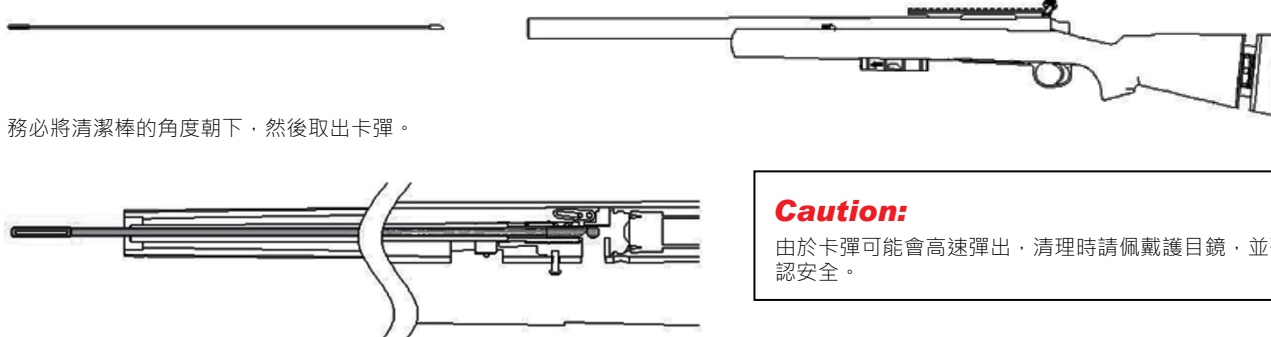

Caution:

由於卡彈可能會高速彈出，清理時請佩戴護目鏡，並確認安全。

12. 爆炸圖

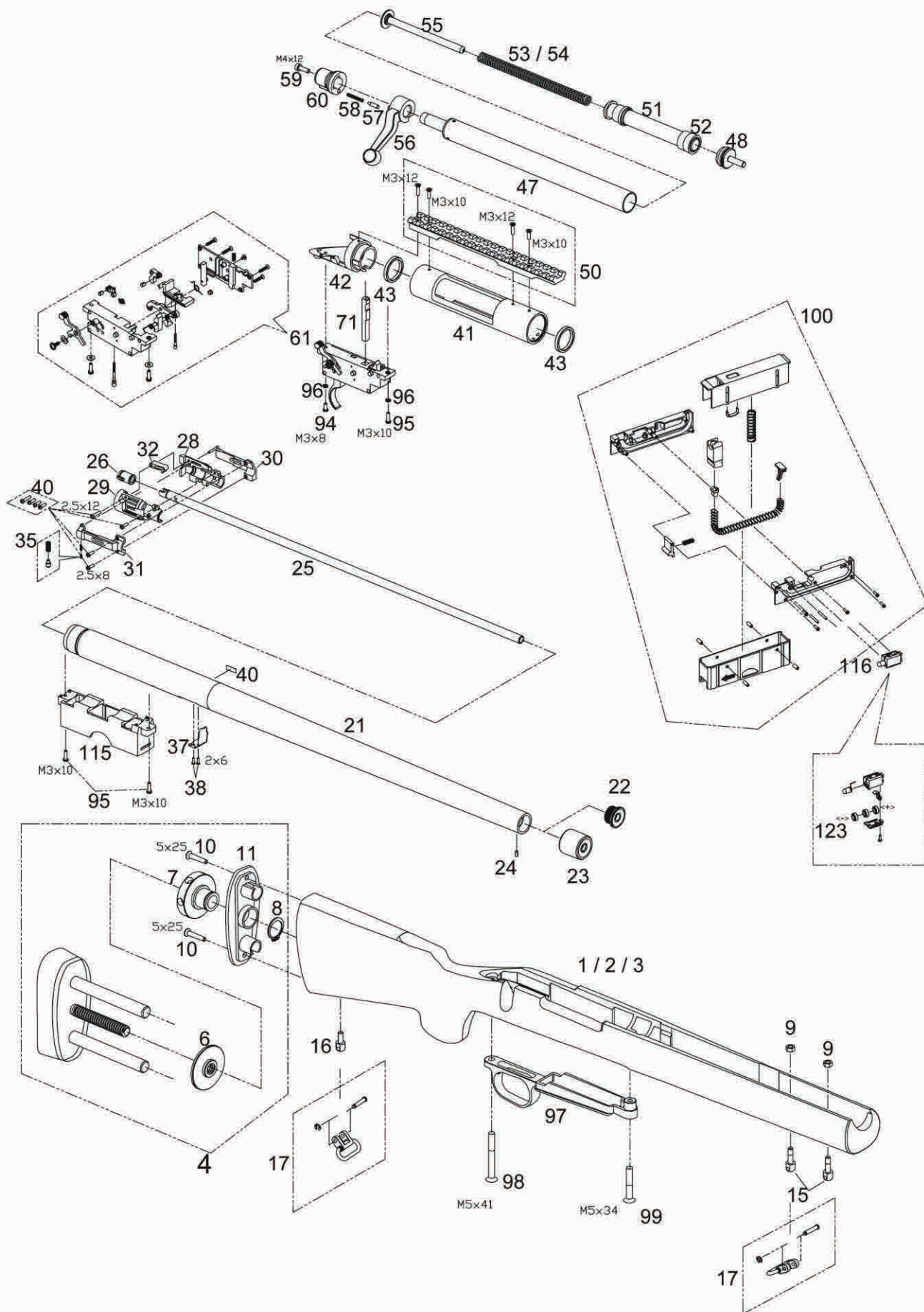



User manual supplemental instruction

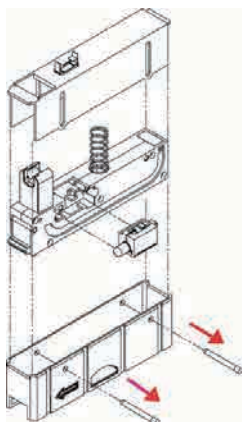

We do the further improvement for better disassembling. Here are some changes on user manual:

Install the LED

1. Remove the 2 pins from the magazine.
2. Disassemble the magazine cover into upper and lower part. Take out the inner case.
3. Install the LED box into the magazine inner case as shown.
4. Assemble the magazine and tighten the 2 pins to finish.

Caution: **A Non-pellet Alert Function**

A Non-pellet Alert Function is available for this rifle. Remove the empty magazine before return the bolt handle is a must. Return the bolt handle furiously may damage the gun.